

KTM 512

Pressure independent balancing and control valve



TA

Pressurisation & Water Quality › Balancing & Control › Thermostatic Control

ENGINEERING ADVANTAGE

High-performing and compact, these pressure-independent control valves for variable flow heating and cooling systems are particularly effective in situations requiring high temperatures and/or pressure drops. They are also suitable for use on the secondary side in district heating and comfort cooling systems. Rust protection is assured due to the electrophoretically painted ductile iron body, while the plug delivers valve characteristic, suitable for modulating control.

> **Inline design**

Inline flow allows high pressure drops without noise.

> **Adjustable flow**

Ensures the design flow.

> **Adapters**

For use with most available actuators.



> Technical description

Application:

Heating and cooling systems.

Functions:

Differential pressure control over the built-in control valve and flow control.

Dimensions:

DN 15-125

Pressure class:

PN 25 and PN 16

Differential pressure (Δp_V):

Max. differential pressure: 1600 kPa = 16 bar (ΔH_{max})

Min. differential pressure:

Low flow (LF): 24 kPa (ΔH_{min})

Normal flow (NF): 40 kPa (ΔH_{min})

High flow (HF): 80 kPa (ΔH_{min})

(Valid for max. position, fully open. Other positions will require lower differential pressure, check with the software TA-Select.)

Temperature:

Max. working temperature:

- with measuring points: 120°C

- without measuring points: 150°C

Min. working temperature: -10°C

Media:

Water or neutral fluids, water-glycol mixtures.

Material:

Valve body: Ductile iron EN-GJS-400

Diaphragms and gaskets: EPDM

Valve plug: EPDM/Stainless steel

Surface treatment:

Electrophoretic painting.

Marking:

TA, DN, PN, Kvs, material and flow direction arrow.

Flanges:

DN 15-50: According to EN-1092-2:1997, type 16.

DN 65-125: According to EN-1092-2:1997, type 21.

Actuators:

KTM 512 can be equipped with adapters for the most common actuators - see "Adapters for actuators".

The max. lift of the actuator must be checked. In the case of a shorter lift the maximum achieved flow will be decreased.

Consult your local sales office for details.

Max. lift of the control valve:

DN 15-50: 10 mm

DN 65-125: 20 mm

Operating function

DN 15-50

1. Fixing nut
2. Throttle
3. Holes for plumbing (throttle)
4. Holes for plumbing (valve body)
5. Venting screws
6. Inline differential pressure controller
7. Valve body
8. Diaphragm
9. Control valve

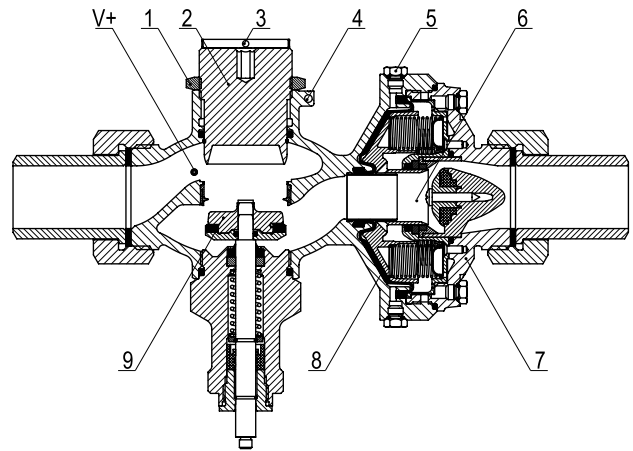

The throttle (2) for flow adjustment, the control valve (9) and the diaphragm operated inline the differential pressure controller (6) are built in series in a common valve body. Pressure upstream of the throttle acts through an internal impulse pipe (V+) to the inlet side of the diaphragm (8). Pressure downstream the control valve acts to the outlet side of the diaphragm together with a spring force. The differential pressure controller pressure relieves the control valve, and at the same time limits the flow to the preset value. As the control valve is pressure relieved, it is possible to use low force actuators.

DN 65-125

1. Venting screws
2. Diaphragm
3. Spring
4. Inline differential pressure controller
5. Valve body
6. Flow adjustment screw
7. Fixing nut
8. Control valve

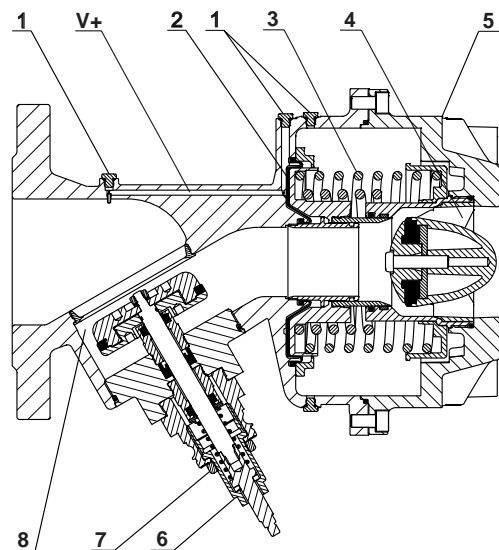

The control valve (8) and the diaphragm operated inline differential pressure controller (4) are built in series in a common valve body. Pressure upstream of the control valve acts through an internal impulse pipe (V+) to the inlet side of the diaphragm (2). Pressure downstream of the control valve acts to the outlet side of the diaphragm together with a spring force. The differential pressure controller pressure relieves the control valve, and at the same time limits the flow to the preset value. As the control valve is equipped with lift limitation device, stepless adjustment of maximum flow is possible. As the control valve is pressure relieved, it is possible to use low force actuators.

Sizing

The valve is capable of achieving a maximum flow according to the previous tables.

Min. differential pressure:

Low flow (LF): 24 kPa (ΔH_{min})

Normal flow (NF): 40 kPa (ΔH_{min})

High flow (HF): 80 kPa (ΔH_{min})

(Valid for max. position, fully open. Other positions will require lower differential pressure, check with the software TA-Select.)

Installation

Install the valve in the return pipe, downstream the consumer, or in the inlet pipe, upstream the consumer. Flow direction is shown by the arrow on the valve body.

Install the valve so that venting is possible and the flow adjustment scale is visible. Check allowed positions of the actuator.

Installation of a strainer upstream of the valve is recommended.

When filling, vent the body by using the venting screws.

Normal pipe fittings

Try to avoid mounting taps and pumps immediately before the valve.

Installation recommendation for accurate measurement due to distortion of fully developed turbulent flow profile.

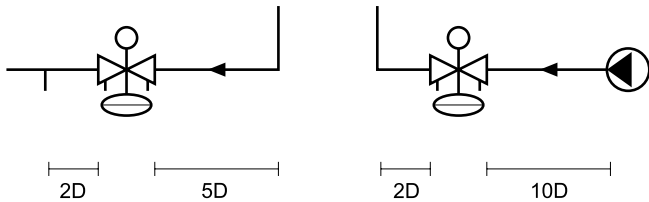

Application example

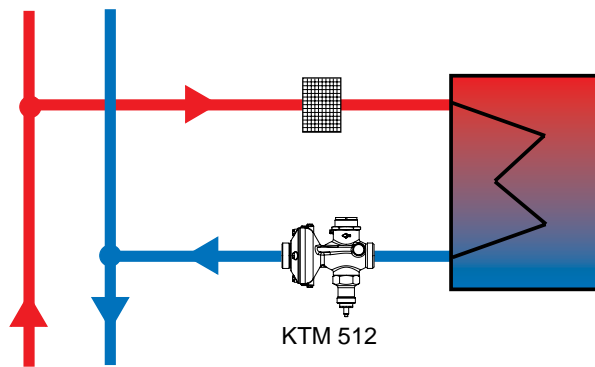

Setting

DN 15-50

Release the fixing nut (1). Turn the flow setting screw (2) clockwise to the position of 0,0 turns. Turn the flow setting screw **anticlockwise** corresponding to the number of turns on the flow chart. Tighten the fixing nut. The flow setting can be sealed by using the holes (3a and 3b) on the flow setting screw and the valve body.

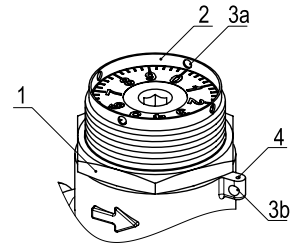

DN 65-125

Release the fixing nut (7). Turn the flow setting screw (6) clockwise to the position of 0,0 turns. Turn the flow setting screw **anticlockwise** corresponding to the number of turns on the flow chart. Tighten the fixing nut.

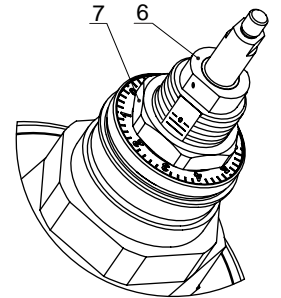

Detailed instructions are delivered with the valves.

Table - Example:

Valid table is delivered with each valve.

KTM 512 DN 15/20 LF					
Position - Einstellung					
	0,0	1,0	2,0	3,0	4,0
,0	0,02	0,29	0,49	0,59	0,72
,1	0,05	0,31	0,50	0,60	0,73
,2	0,07	0,33	0,51	0,62	0,74
,3	0,10	0,35	0,52	0,63	0,75
,4	0,13	0,37	0,53	0,64	0,76
,5	0,16	0,39	0,54	0,66	0,77
,6	0,18	0,41	0,55	0,67	0,78
,7	0,21	0,43	0,56	0,68	0,79
,8	0,24	0,45	0,57	0,69	0,80
,9	0,26	0,47	0,58	0,71	0,81

Flow - Volumenstrom (m³/h)

$p_1=4\text{bar}$ $p_2=3\text{bar}$ $\Delta p=1\text{bar}$
 $\Delta p \ll 1 \text{ bar} \Rightarrow \text{Flow} = =$

Measuring accuracy

Kv deviation at different settings (LF/NF/HF)

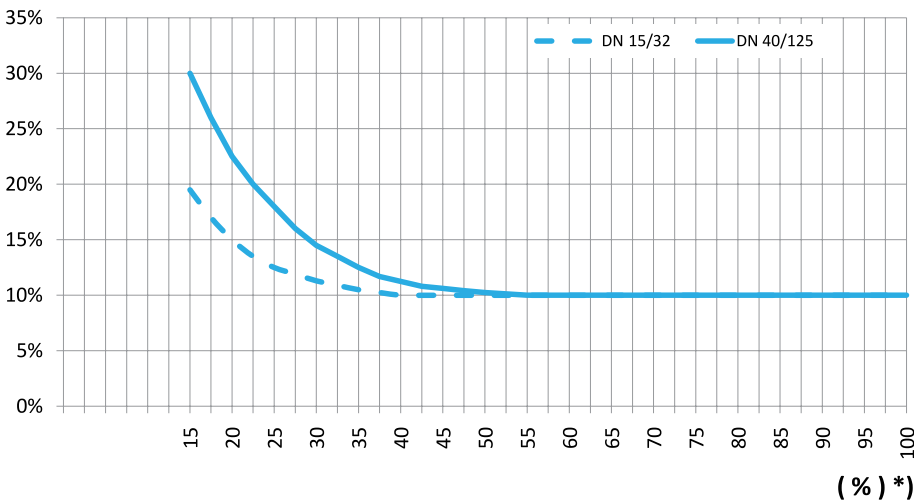

*) Setting (%) of fully open valve.

Actuator recommendation at varying inlet pressures

The minimum actuator force required to operate the KTM 512 valves is dependent upon the maximum inlet pressure of the system. The following table shows the actuator recommendations from TA at varying inlet pressures.

For other inlet pressures, the graph (Fig. 1) should be used to establish the minimum actuator force required.

Valve size		Stroke (mm)	Theoretical minimum actuator force (N) at varying static inlet pressures				
			5 bar	10 bar	15 bar	20 bar	25 bar
DN 15/20	LF	10	110	135	170	200	235
	NF		110	135	170	200	235
	HF		115	140	175	205	240
DN 25/32	LF		130	155	190	220	255
	NF		140	165	195	230	260
	HF		160	185	215	250	280
DN 40/50	LF		150	175	205	240	270
	NF		170	190	225	255	290
	HF		205	225	255	290	320
DN 65	LF	20	360	410	485	560	630
	NF		400	445	520	595	670
	HF		475	520	595	665	740
DN 80	LF		415	465	535	610	685
	NF		480	520	595	670	740
	HF		600	635	710	785	855
DN 100	LF		480	520	595	670	745
	NF		565	605	675	750	825
	HF		740	765	840	915	985
DN 125	LF		595	630	705	775	850
	NF		730	755	830	900	975
	HF		995	1005	1075	1150	1225

EAN	Article No	TA recommended actuators	Actuator force (N)	Max. stroke (mm)
3831112504967	44 756-975	TA-R25/24V	500	10
3831112506510	61 055-003	TA MC55/24V	600	20
3831112511675	61 100-001	TA MC100/24V	1000	20
3831112507050	50 358-020	TA-NV24	1000	20
3831112512160	61 160-001	TA MC160/24V	1600	30
3831112512115	50 358-120	TA-NVG24	1600	20

Note: TA-R25/F24 fast acting version (Article No 44 756-977) is not recommended.

Fig. 1

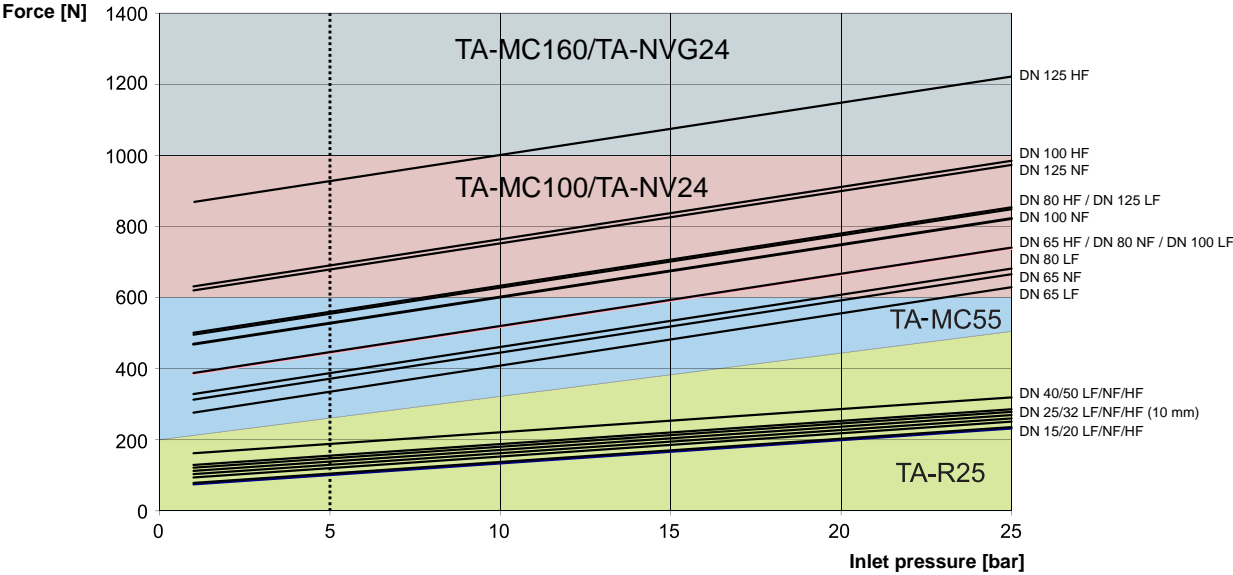

Articles – With measuring points (max. 120°C)

DN 15-50

Male thread – Threads according to ISO 228

PN 25

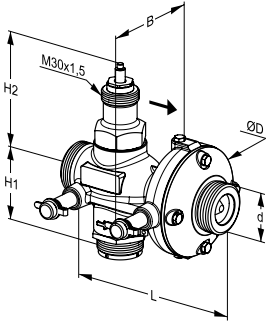

DN	d	D	L	H1	H2	B	q _{max} [m ³ /h]	Kg	EAN	Article No
LF, low flow										
15/20	G1	78	110	45	98	83	0,8	1,5	3831112507692	52 796-220
25/32	G1 1/4	97	150	53	94	90	3,2	2,0	3831112507722	52 796-225
40/50	G2	125	190	66	94	106	7,6	4,5	3831112507753	52 796-240
NF, normal flow										
15/20	G1	78	110	45	98	83	1,0	1,5	3831112507708	52 796-020
25/32	G1 1/4	97	150	53	94	90	3,8	2,0	3831112507739	52 796-025
40/50	G2	125	190	66	94	106	9,5	4,5	3831112507760	52 796-040
HF, high flow										
15/20	G1	78	110	45	98	83	1,4	1,5	3831112507715	52 796-420
25/32	G1 1/4	97	150	53	94	90	5,4	2,0	3831112507746	52 796-425
40/50	G2	125	190	66	94	106	12,6	4,5	3831112507777	52 796-440

DN 65-125

Flanges – Do not need any separate connections.

PN 25 (DN 65-80 also fit PN 16 flanges)

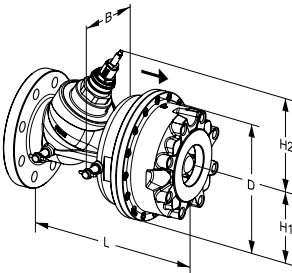

DN	D	L	H1	H2	B	q _{max} [m ³ /h]	Kg	EAN	Article No
LF, low flow									
65	220	290	110	175	136	15,4	22	3831112509634	52 791-765
80	220	310	110	175	134	16,7	24	3831112509665	52 791-780
100	320	350	160	196	179	26,6	54	3831112509511	52 791-790
125	320	400	160	196	178	35,6	58	3831112509573	52 791-791
NF, normal flow									
65	220	290	110	175	136	21,6	22	3831112509641	52 791-865
80	220	310	110	175	134	22,7	24	3831112509672	52 791-880
100	320	350	160	196	179	41,2	54	3831112509528	52 791-890
125	320	400	160	196	178	54,9	58	3831112509580	52 791-891
HF, high flow									
65	220	290	110	175	136	29,6	22	3831112509658	52 791-965
80	220	310	110	175	134	32,5	24	3831112509689	52 791-980
100	320	350	160	196	179	50,6	54	3831112509535	52 791-990
125	320	400	160	196	178	66,8	58	3831112509597	52 791-991

PN 16

DN	D	L	H1	H2	B	q _{max} [m ³ /h]	Kg	EAN	Article No
LF, low flow									
100	320	350	160	196	179	26,6	54	3831112512986	52 791-490
125	320	400	160	196	178	35,6	58	3831112513044	52 791-491
NF, normal flow									
100	320	350	160	196	179	41,2	54	3831112512979	52 791-590
125	320	400	160	196	178	54,9	58	3831112513037	52 791-591
HF, high flow									
100	320	350	160	196	179	50,6	54	3831112509504	52 791-690
125	320	400	160	196	178	66,8	58	3831112509566	52 791-691

→ = Flow direction

Articles – Without measuring points (max.150°C)

DN 15-50

Male thread – Threads according to ISO 228

PN 25

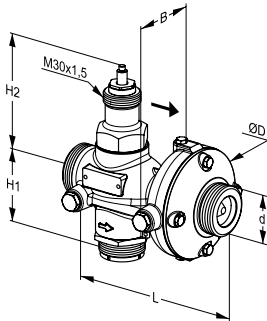

DN	d	D	L	H1	H2	B	q _{max} [m ³ /h]	Kg	EAN	Article No
LF, low flow										
15/20	G1	78	110	45	98	55	0,8	1,5	3831112529274	52 761-820
25/32	G1 1/4	97	150	53	94	62	3,2	2,0	3831112529304	52 761-825
40/50	G2	125	190	66	94	78	7,6	4,5	3831112529335	52 761-840
NF, normal flow										
15/20	G1	78	110	45	98	55	1,0	1,5	3831112529281	52 762-820
25/32	G1 1/4	97	150	53	94	62	3,8	2,0	3831112529311	52 762-825
40/50	G2	125	190	66	94	78	9,5	4,5	3831112529342	52 762-840
HF, high flow										
15/20	G1	78	110	45	98	55	1,4	1,5	3831112529267	52 765-720
25/32	G1 1/4	97	150	53	94	62	5,4	2,0	3831112529298	52 765-725
40/50	G2	125	190	66	94	78	12,6	4,5	3831112529328	52 765-740

DN 65-125

Flanges – Do not need any separate connections.

PN 25 (DN 65-80 also fit PN 16 flanges)

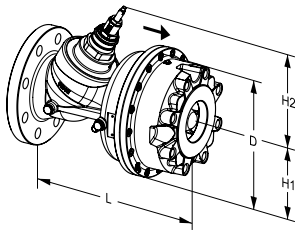

DN	D	L	H1	H2	q _{max} [m ³ /h]	Kg	EAN	Article No
LF, low flow								
65	220	290	110	175	15,4	22	3831112529366	52 761-865
80	220	310	110	175	16,7	24	3831112529397	52 761-880
100	320	350	160	196	26,6	54	3831112529182	52 761-890
125	320	400	160	196	35,6	58	3831112529243	52 761-891
NF, normal flow								
65	220	290	110	175	21,6	22	3831112529373	52 762-865
80	220	310	110	175	22,7	24	3831112529403	52 762-880
100	320	350	160	196	41,2	54	3831112529199	52 762-890
125	320	400	160	196	54,9	58	3831112529250	52 762-891
HF, high flow								
65	220	290	110	175	29,6	22	3831112529359	52 765-765
80	220	310	110	175	32,5	24	3831112529380	52 765-780
100	320	350	160	196	50,6	54	3831112529175	52 765-790
125	320	400	160	196	66,8	58	3831112529236	52 765-791

PN 16

DN	D	L	H1	H2	q _{max} [m ³ /h]	Kg	EAN	Article No
LF, low flow								
100	320	350	160	196	26,6	54	3831112529151	52 761-790
125	320	400	160	196	35,6	58	3831112529212	52 761-791
NF, normal flow								
100	320	350	160	196	41,2	54	3831112529168	52 762-790
125	320	400	160	196	54,9	58	3831112529229	52 762-791
HF, high flow								
100	320	350	160	196	50,6	54	3831112529144	52 765-690
125	320	400	160	196	66,8	58	3831112529205	52 765-691

→ = Flow direction

Adapters for actuators

For DN 15-50

For recommended actuators

For actuator	EAN	Article No
TA-R25	3831112511996	52 757-031
TA-MC55, TA-MC100	3831112512023	52 757-035
TA-NV24, Belimo UNV 003	3831112512061	52 757-041

For other actuators

For actuator	EAN	Article No
Belimo NRDVX-3-T-SI	3831112503595	52 757-001
JCI VA-745x	3831112505490	52 757-002
Lineg NL	3831112505339	52 757-007
Danfoss AMV 10, 13, 20, 23	3831112503465	52 757-008
Samson 5825	3831112500259	52 757-011
Clorius V2.05, V4.10	3831112500167	52 757-016
Schneider Electric FORTA M400, M800	3831112503007	52 757-019
Siemens SQX, SKD, SKB, SAX	3831112505360	52 757-022
HORA MC25	3831112504950	52 757-024
TA-MC100 FSE/FSR	3831112511538	52 757-026
HORA MC45	3831112511965	52 757-028
TA-NV24 , Belimo UNV 002	3831112511972	52 757-029
Sauter AVM 104/114	3831112511989	52 757-030
JCI VA-715x, VA-720x, VA-774x	3831112512009	52 757-033
K&P MD200	3831112512030	52 757-036
Belimo NRDVX-SR-T-CA	3831112512047	52 757-037
TA-R25 plastic	3831112512054	52 757-038
Honeywell ML	3831112512078	52 757-042

For DN 65-125

For recommended actuators

For actuator	EAN	Article No
TA-NV24, Belimo UNV 003	3831112512283	52 757-901
TA-MC 55	3831112509269	52 757-905
TA-MC100	3831112512085	52 757-907
TA-MC100 FSE/FSR	3831112511781	52 757-912
TA-MC160	3831112511910	52 757-913

For other actuators

For actuator	EAN	Article No
Danfoss AMV 55	3831112509252	52 757-902
Siemens SQX, SKD, SAX	3831112510661	52 757-903
Sauter AVN 224, AVF 234, AVM 234	3831112504486	52 757-904
Schneider Electric Forta	3831112512092	52 757-906

Connections

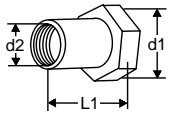

With female thread
Threads according to ISO 228

d1	d2	L1*	EAN	Article No
G1	G1/2	26	3831112501027	52 759-015
G1	G3/4	32	3831112501034	52 759-020
G1 1/4	G1	47	3831112501041	52 759-025
G1 1/4	G1 1/4	52	3831112501058	52 759-032
G2	G1 1/2	52	3831112503489	52 759-040
G2	G2	64,5	3831112503205	52 759-050

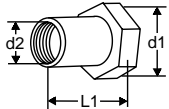

With female thread Rc
Threads according to ISO 7-1

d1	d2	L1*	EAN	Article No
G1	Rc1/2	26	3831112527454	52 751-301
G1	Rc3/4	32	3831112527461	52 751-302
G1 1/4	Rc1	47	3831112527478	52 751-303
G1 1/4	Rc1 1/4	52	3831112527485	52 751-304
G2	Rc1 1/2	52	3831112527492	52 751-305
G2	Rc2	64,5	3831112527508	52 751-306

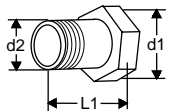

With male thread
Threads according to ISO 7

d1	d2	L1*	EAN	Article No
G1	R1/2	34	3831112500983	52 759-115
G1	R3/4	40	3831112500990	52 759-120
G1 1/4	R1	40	3831112501003	52 759-125
G1 1/4	R1 1/4	45	3831112501010	52 759-132
G2	R1 1/2	45	3831112503342	52 759-140
G2	R2	50	3831112503472	52 759-150

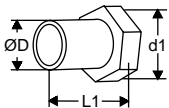

For welding

d1	D	L1*	EAN	Article No
G1	20,8	37	3831112500945	52 759-315
G1	26,3	42	3831112500952	52 759-320
G1 1/4	33,2	47	3831112500969	52 759-325
G1 1/4	40,9	47	3831112500976	52 759-332
G2	48,0	47	3831112501140	52 759-340
G2	60,0	52	3831112501294	52 759-350

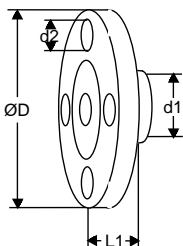

With flange
Flange according to EN-1092-2:1997, type 16.
Length flange to flange according to EN-558-2-1995, serie 1.

d1	d2	D	L1*	EAN	Article No
G1	M12	95	10	3831112501065	52 759-515
G1	M12	105	20	3831112501072	52 759-520
G1 1/4	M12	115	5	3831112504318	52 759-525
G1 1/4	M16	140	15	3831112501096	52 759-532
G2	M16	150	5	3831112504325	52 759-540
G2	M16	165	20	3831112501317	52 759-550

*) Fitting length (from the gasket surface to the end of the connection).

Accessories

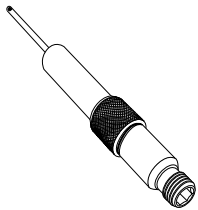

Measuring point

Extensions 60 mm.

Can be installed without draining of the system.

L	EAN	Article No
60	7318792812804	52 179-006



Venting screw

d	EAN	Article No
M6	3831112527980	52 759-211

The products, texts, photographs, graphics and diagrams in this document may be subject to alteration by TA Hydronics without prior notice or reasons being given. For the most up to date information about our products and specifications, please visit www.tahydronics.com.

6-10-25 KTM 512 06.2013